

# Data Sheet



Article number: 12858100025840

Description: KLEE-coil 858 100 025.840  
M2,5 Brass

## Measures

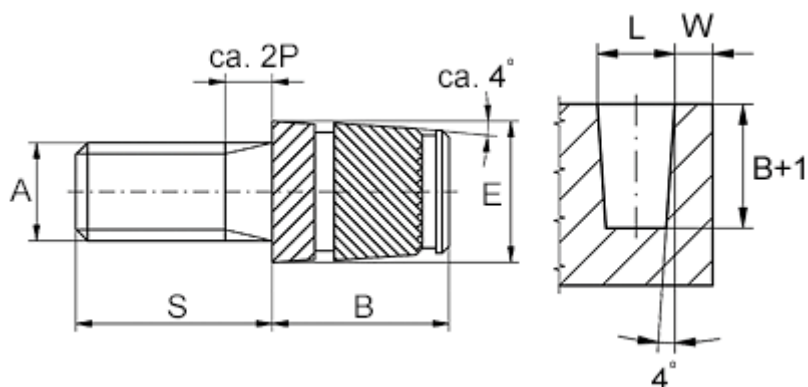

Male thread A	= M2,5x0,45
Min distance to edge W	= 1.5
Mounting length B	= 5.0
Outer diameter E	= 4.1
Pin length S	= 10
Recommended bore diameter W +0.1	= 3.8